

## Overview

# Cable Pulley Ø 52 mm / Ø 8 mm - with steel bracket

Product number: 04400099



## Options

### PU

1

Box

### Version:

Ball bearing

## Description

Thanks to two ball bearings, **the 52 mm pulley** is guided particularly securely on the axle and has a high level of stability under shear loads.

The galvanised steel bracket can be attached to your construction with an **M8 screw**. The retaining bracket can also be detached from the pulley to make installation **as easy as possible**, even in installation situations that are difficult to access.



- Impact resistant pulley
- Galvanised steel bracket
- Two ball bearings
- Load capacity: up to 280 kg
- Made in Germany

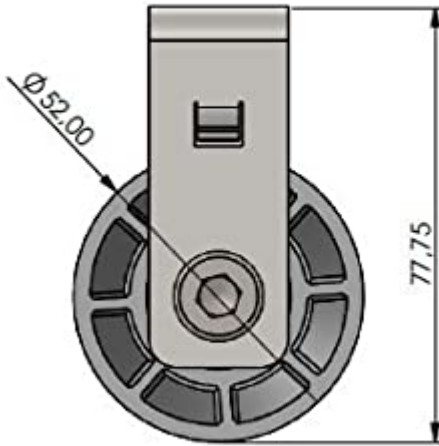

- Outer diameter: 52 mm
- Total height: 77,75 mm

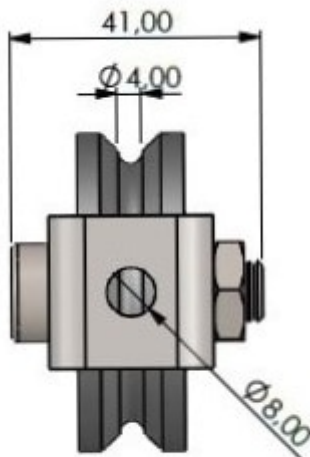

- Total width: 20 mm
- Rope diameter: up to  $\text{Ø } 8$  mm
- Fastening with M8 screw / bolt